

Autonics Digital Fiber Optic Amplifier Communication Converter BFC SERIES INSTRUCTION MANUAL



Thank you for choosing our Autonics product. Please read the following safety considerations before use.

Safety Considerations

- Please observe all safety considerations for safe and proper product operation to avoid hazards.
- Warning symbol represents caution due to special circumstances in which hazards may occur.
- Warning** Failure to follow these instructions may result in serious injury or death.
- Caution** Failure to follow these instructions may result in personal injury or product damage.

Warning

- Fail-safe device must be installed when using the unit with machinery that may cause serious injury or substantial economic loss. (e.g. nuclear power control, medical equipment, ships, vehicles, railways, aircraft, combustion apparatus, safety equipment, crime/disaster prevention devices, etc.) Failure to follow this instruction may result in fire, personal injury, or economic loss.
- Install the unit on DIN rail to use. Failure to follow this instruction may result in fire.
- Do not connect, repair, or inspect the unit while connected to a power source. Failure to follow this instruction may result in fire.
- Check 'Connections' before wiring. Failure to follow this instruction may result in fire.
- Do not disassemble or modify the unit. Failure to follow this instruction may result in fire.

Caution

- Use the unit within the rated specifications. Failure to follow this instruction may result in fire or product damage.
- Use dry cloth to clean the unit, and do not use water or organic solvent. Failure to follow this instruction may result in fire.
- Do not use the unit in the place where flammable/explosive/corrosive gas, humidity, direct sunlight, radiant heat, vibration, impact, or salinity may be present. Failure to follow this instruction may result in fire or explosion.

Proper Usage

Before using this communication converter unit, depending on the usage environment, keep following items handy.

- Visit our web site(www.autonics.com) to download.
- DAQMaster program(Integrated device management program), User Manual
- SCM-US Driver(USB driver, Serial port driver), Manual
- SCM-US48I Driver(USB driver, Serial port driver), Manual
- SCM-38I Manual
- Communication converter unit BFC User Manual For Communication

Dimensions

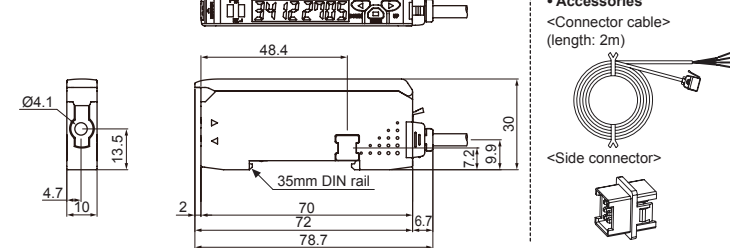

Connections

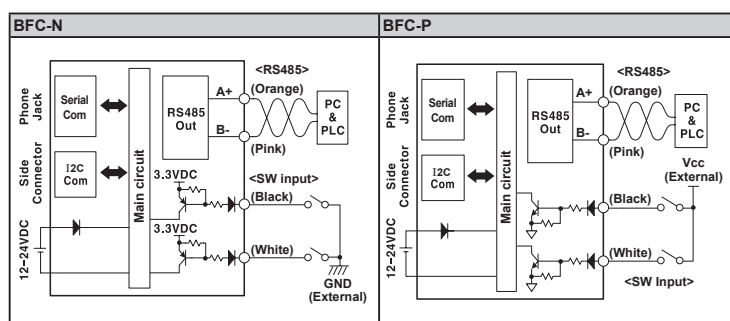

The above specifications are subject to change and some models may be discontinued without notice.
 Be sure to follow cautions written in the instruction manual, user manual and the technical descriptions (catalog, homepage).

Specifications

Model	NPN Solid-state input BFC-N	PNP Solid-state input BFC-P
Power supply ^{※1}	12-24VDC±10%	
Current consumption	Max. 40mA	
SW input (SW1, SW2)	LOW: 0-1V, HIGH: 5-24V SW1/SW2 - HH: Standby, HL: BANK0, LH: BANK1, LL: BANK2	SW1/SW2 - LL: Standby, LH: BANK0, HL: BANK1, HH: BANK2
Communication function	RS485 Communication, Serial Communication, SW input	
Communication speed	1200, 2400, 4800, 9600, 19200, 38400bps	
Indication	<ul style="list-style-type: none"> Parameter: Red 4digit 7segment Setting value: Green 4 digit 7 segment Indicator: TX indicator(Red), RX indicator(Green) 	
Function	<ul style="list-style-type: none"> Real-time monitoring (incident light level, on/off state) Executes every BF5 feature and sets parameter by external device (Master) 	
Environment	<ul style="list-style-type: none"> Ambient temperature: -10 to 50°C, Storage: -20 to 60°C Ambient humidity: 35 to 85%RH, Storage: 35 to 85%RH 	
Vibration	1.5mm amplitude at frequency of 10 to 55Hz(for 1 min) in each X, Y, Z direction for 2 hours	
Shock	500m/s ² (approx. 50G) in each X, Y, Z direction for 3 times	
Protection structure	IP40(IEC standards)	
Material	Case: PBT, Cover: PC	
Accessory	Connector cable(Ø4mm, 4-wire, 2m / AWG22, Core diameter: 0.08mm, Number of cores: 60, Insulator diameter: Ø1.25mm), side connector	
Approval	CE	
Unit weight	Approx. 15g	

※1: Power is supplied from the voltage of the amplifier unit connected by a side connector.
 ※Environment resistance is rated at no freezing or condensation.

Unit Description

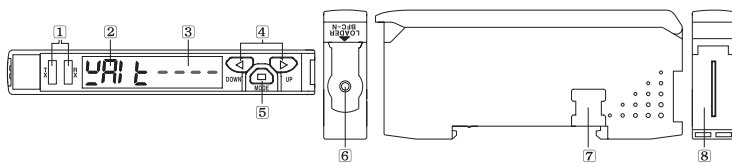

- TX(Send)-Red LED, RX(Receive)-Green LED:** Turns on when communicates and inputs SW.
- Parameter indication(4digit Red 7segment):** Indicates parameter and processes of communication instruction/execution.
- Setting value indication(4digit Green 7segment):** Indicates setting value and process of communication instruction/execution.
- UP, DOWN key:** To modify setting value.
- MODE key:** To shift or select parameter when entering parameter setting mode.
- PC loader port:** In case of PC communication, use USB to Serial converter(SCM-US, sold separately).
- Side cover:** To connect an amplifier unit, use a side connector(accessory). Remove the side cover to connect the amplifier unit.
- Connector cable port:** The terminal for attaching a connector cable(accessory) is used for RS485 communication or SW input.

Installations

- DIN rail installations**
 - Attachment<Picture 1>**
 - Hang up the backside holder of the communication converter unit on DIN rail.
 - Press the front part of the communication converter unit toward DIN rail.
 - Detachment<Picture 2>**
 - Slide the back part of the communication converter unit as shown in figure ①.
 - Lift up the communication converter unit as shown in figure ②.

Communication converter unit(BFC Series) and Amplifier unit(BF5 Series) Connection

- Remove the side cover at the side of communication converter unit where amplifier unit will be connected.
 - Attach the side connector to the socket on the side of the communication converter.
 - After attaching the communication converter unit and the amplifier unit to the DIN rail, push gently to have both units fastened into each other.
- ※Improper connection may cause malfunction.
 ※Do not supply the power while connecting or disconnecting.

Connector cable attachment and detachment

- Attachment<Picture 3>**
Insert the connector cable into the installed communication converter unit on DIN rail until it clicks.
- Detachment<Picture 4>**
Pull out the connector cable with pressing the connector cable lever downside.

USB to Serial converter(SCM-US) attachment and detachment

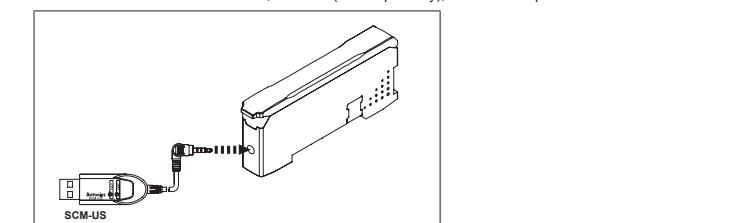

Communication Mode

This communication converter unit supports 2 communication modes and SW input mode. You can use only 1 mode of 3 modes.

1) Serial communication

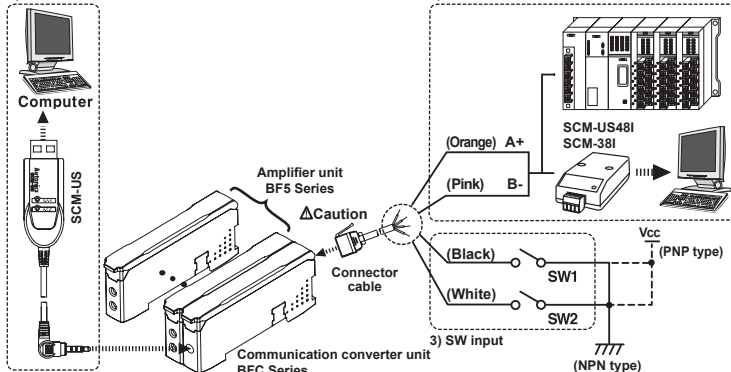

Caution: Do not connect a powered BF5 connector cable to a communication converter unit(BFC). (It may cause damage the product.)

2) RS485 communication

- PLC connection
 - Connect the USB to Serial converter(SCM-US, sold separately) to the PC loader port for communicating with PC.
 - It is very easy to manage parameters and monitor data of connected amplifier units(BF5 Series) using the integrated management program DAQMaster(free). (Refer to DAQMaster and amplifier unit manuals)

3) SW input

- PLC connection
 - Connect directly to a PLC using RS485 communication cable of the communication converter unit.
 - Amplifier units(BF5 Series) can be controlled through PLC. (Refer to communication converter unit(BFC) communication manual)

PC connection

- Connect PC using Communication converter(SCM-38I or SCM-US48I, sold separately). (Refer to Communication converter SCM series manual)
- Same as "1)Serial Communication information line ②".

※Following is a screen of DAQMaster properties window of a computer connected communication converter unit.

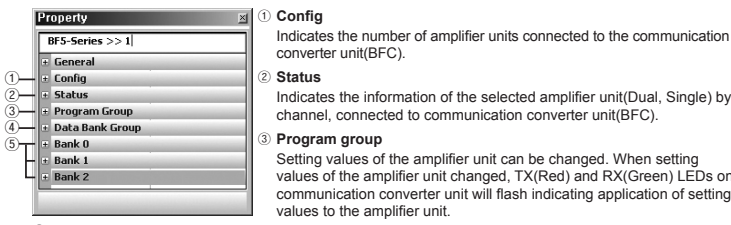

- Config**
Indicates the number of amplifier units connected to the communication converter unit(BFC).
- Status**
Indicates the information of the selected amplifier unit(Dual, Single) by channel, connected to communication converter unit(BFC).
- Program group**
Setting values of the amplifier unit can be changed. When setting values of the amplifier unit changed, TX(Red) and RX(Green) LEDs on communication converter unit will flash indicating application of setting values to the amplifier unit.

④ **Data Bank group**
Data bank and group teaching features of amplifier unit can be set. Amplifier unit can be initialized as well.

※Indications appear on communication converter and amplifier units depending on applied instruction are shown below.

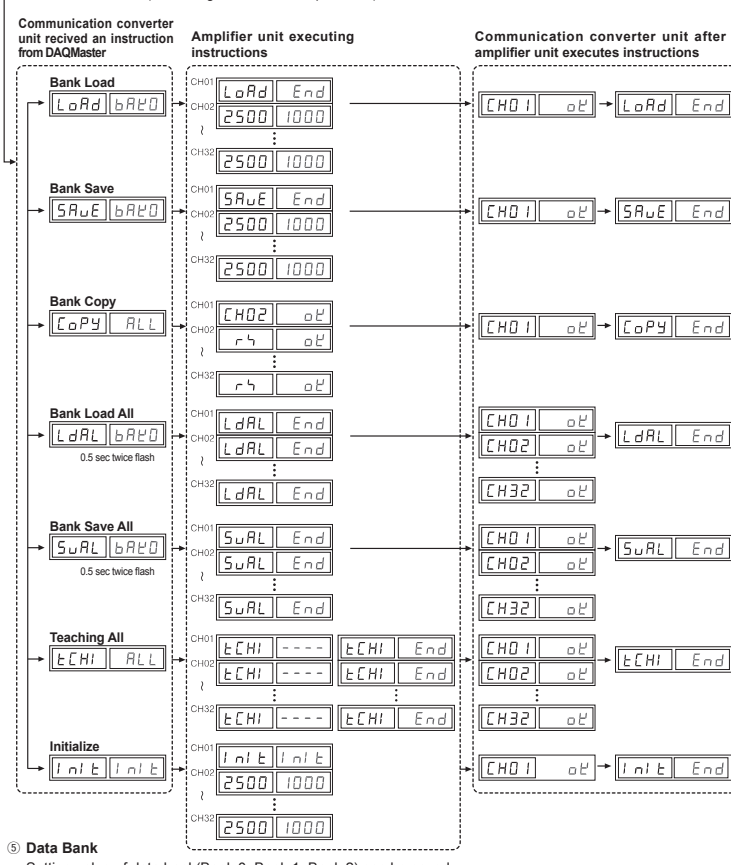

SW input

SW input is a feature which allows amplifier unit connected with the communication converter unit to load all banks. Applying signals to SW1(Black) and SW2(White) of the connector cables which is connected to the communication converter unit allows change of banks as shown in chart 1. (SW input signal duration should be longer than 3 seconds.)

[Chart1] Bank selection table based on SW input

	Bank	NPN		PNP	
		SW1	SW2	SW1	SW2
1	Standby signal(Using set Bank)	H	H	L	L
2	Bank 0	H	L	L	H
3	Bank 1	L	H	L	L
4	Bank 2	L	L	H	H

※Indications appear on communication converter and amplifier units depending on applied instruction are shown below.

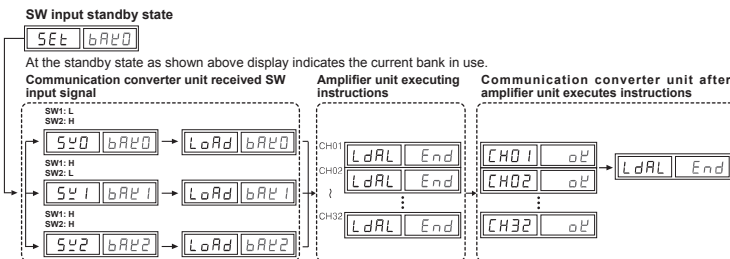

Communication Specification

Standard	EIA RS485	Standard	EIA RS485
Maximum connections	31(Address setting: 01 to 99)	Response waiting time	20 to 99ms
Communication method	2-wire half duplex	Start bit	1bit(Fixed)
Synchronization method	Asynchronous	Stop bit	1bit, 2bit
Effective communication distance	Max. 800m	Parity bit	None, Even, Odd
Communication speed	1200, 2400, 4800, 9600, 19200, 38400bps	Data bit	8bit(Fixed)
		Protocol	Modbus RTU

※It is not allowed to set overlapping communication address at the same communication line.
 ※Please use a proper twist pair for RS485 communication.

Parameter Setting

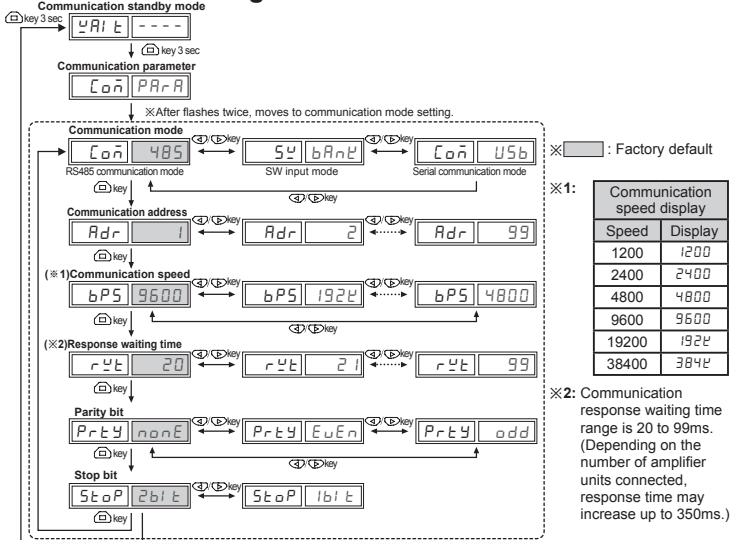

Troubleshooting

Error Code	Description	Solution
E-r	Reading/Writing errors occur while processing data in EEPROM of amplifier unit.	Check the circuitry around EEPROM inside the product.
E-rb	Slave fails to execute Master's group instructions such as Copy/Load/Save/Teaching sent through communication line due to unstable communication line. Other communication problems.	Check the connection status between communication unit and amplifier units. Check the circuitry around the side connector and hardware condition.

Solution methods for communication problems

- Communication errors during Serial or RS485 connections.
 - Check if the communication mode selected in communication converter unit suits installation environment.
 - Check and equalize the address of communication converter unit and address set in DAQMaster.
 - Check and equalize the communication port of communication converter unit and the communication port number set in DAQMaster.
- Communication errors during SW signal input.
 - Check if the communication mode set in communication converter unit is SW input mode(SW Bank).
 - Check if the connections are made thoroughly depending on NPN or PNP input type.

Cautions during Use

- Follow instructions in 'Cautions during Use'. Otherwise, it may cause unexpected accidents.
- When connecting DC relay or other inductive load to the output, remove surge by using diode or varistor.
- Wire as short as possible and keep away from high voltage lines or power lines, to prevent surge and inductive noise.
- Use the product, after 3 sec of supplying power.
- When using switching mode power supply to supply power, ground F.G. terminal and connect a condenser between 0V and F.G. terminal to remove noise.
- Since external disturbance light (sunlight, fluorescent lighting, etc.) can cause product malfunction, use the product with a light shield or slit.
- Be cautious that this product is non-insulated.
- This unit may be used in the following environments.
 - Indoors (in the environment condition rated in 'Specifications')
 - Altitude max. 2,000m
 - Pollution degree 2
 - Installation category III

Major Products

Autonics Corporation
<http://www.autonics.com>

■ HEAD QUARTERS:
 18, Bamsong-ro 513beon-gil, Haeundae-gu, Busan, South Korea, 48002
 TEL: 82-51-519-3232
 E-mail: sales@autonics.com

■ Major Products:
 Photoelectric Sensors, Temperature Controllers, Fiber Optic Sensors, Temperature/Humidity Transducers, Door Sensors, SSRs/Power Controllers, Door Side Sensors, Counters, Area Sensors, Timers, Proximity Sensors, Panel Meters, Pressure Sensors, Tachometer/Pulse (Rate) Meters, Rotary Encoders, Display Units, Connector/sockets, Sensor Controllers, Switching Mode Power Supplies, Control Switches/Lamps/Buzzers, I/O Terminal Blocks & Cables, Stepper Motors/Drivers/Motion Controllers, Graphic/Logic Panels, Field Network Devices, Laser Marking System (Fiber, CO₂, Nd: YAG), Laser Welding/Cutting System.